

## SEA FROST BAIT FREEZER

BF1 ~ BF2 ~ BF3 110-VOLT  
**Pre-charged**

### DESCRIPTION

The Sea Frost Freezer system consists of several parts: The cold plates or wrapped box liner (hidden cooling coils), a refrigerant control valve, copper connecting lines, a receiver filter drier with sight glass, a compressor / condensing unit and a thermostat.

### OPERATION

With the thermostat in the “on” position, the compressor, fan, and pump (if equipped) will operate. Ten minutes after starting the compressor the area near the valve or the top of a hidden coil box will begin to cool and frost.

**If you do not observe cooling, with the compressor and fan running, switch off the unit to avoid damage.**

Within a few minutes of starting the Bait Freezer, the tubing in close proximity to the valve and the valve itself will be noticeably cold. **(If after 20 minutes of operation the cooling in this area is not observed, do not continue to operate the system.)**

After several hours, the box temperature will cool to well below freezing. The first plate or the top section of a wrapped box will cool first. Because it freezes first, all the moisture suspended in the air within the box condenses and freezes at this plate. Frost is not a good indication of proper operation; check the temperature with a thermometer. When the box and contents cool to the desired setting, the compressor and fan will cycle on and off periodically to maintain the set temperature.

## CONDENSING UNIT LOCATION AND MOUNTING

### Air Cooled

The design of the Bait Freezer (BF) allows the air-cooled condensing unit to be placed in an enclosed space such as a locker or engine room.

Mount the unit level with the compressor at the bottom. The unit may be bulkhead or platform mounted. Rubber Wellnut inserts are installed on the bottom and back of the condensing unit to attach to brackets or shelving. The Wellnut require ¼-20 machine screws.

### Air and Water Cooled

The condensing unit should be mounted with the compressor at the bottom parallel to the boat's water line at rest. Air is drawn through the unit and discharges at the fan screen on the upper left side. Cooling water from an air conditioning system manifold or separate pump may be connected to the water fittings on the left side.

Water-cooling is standard on BF2 and BF3 models. Water from an air conditioning pump manifold can be plumbed into the BF condensing unit and triggered by the 110-volt supply labeled "pump" or a dedicated pump can be installed. A flow of two to three GPM is sufficient. (Pump draw not to exceed 2.5 amps at 110-volts.) Use of water-cooling is not mandatory; the unit will operate with air-cooling only. If the condensing unit is to be mounted in a confined area with little ventilation or a very hot engine room the water-cooling should be connected.

### Installation Requirements

- **Never block the inlet nor outlet.** Service access and installation requires that the front and left end (inlet/outlet side) be exposed. The duct hose will require 4" of clearance past the end of the unit.
- **Provide for driest, coolest air for intake.** Use standard 4" duct hose to draw air in from the cabin area to insure the coolest, driest air supply. Intake ducting from the exterior of the boat may cause damp salt air to be drawn in which will reduce unit life. For intake or exhaust through a finished panel, order a flange grill.
- **Discharge does not need ducting if a vent in the area allows warm air to escape.** An un-ducted unit in a poorly ventilated small space will heat the air, lowering the capacity of the unit and possibly causing damage by overheating the compressor.
- **Total combined air duct length for intake and discharge should not exceed six feet.**

## EVAPORATOR PLATE INSTALLATION

Mount the plates on opposite walls as high as possible to take advantage of thermal convection. Install the plates with the Wellnut, spacers and screws provided.

The plate(s) mounts with a Wellnut expandable neoprene blind hole fastener. A template or the plate itself should be used to locate the mounting holes. Drill a 3/16" pilot hole. Increase this hole to 3/8". Install the screw into the plate through the spacer then tighten the screw in the Wellnut. Install the plate pushing the rubber mounts in to the pre-drilled holes. Tighten the screws.

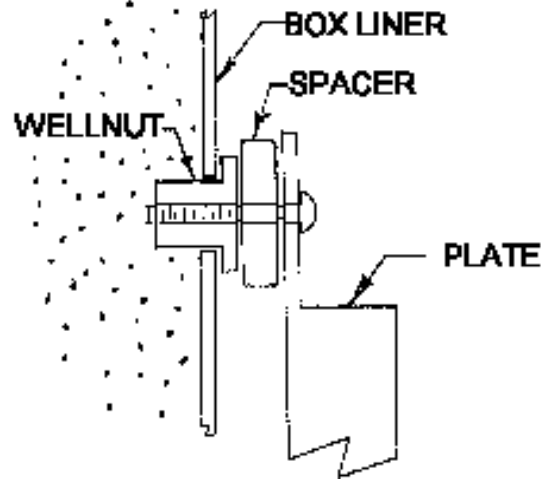

## QUICK CONNECT FITTING INSTRUCTIONS

Aeroquip quick connect fittings are used in this pre-charged system. These fittings reseal upon disconnecting and do not leak during assembly.

**If installing this compressor in an existing system. Use LSA line adapters to interface with the new compressor. Attach, evacuate using a vacuum pump, leak check, and then add a vapor charge of R-134a before connecting to the pre-charged condensing unit.**

**In a pre charged system installation make all the connections up to the compressor first.** The last two connections should be the suction fitting then the discharge fitting.

To assemble, remove the heat shrink and plastic cap. Be sure the threads and the end of the fittings are clean.

Finger tighten the fittings to avoid cross threading. Tighten to wrench snug and then pull up 1/16 turn.

When making all connections, USE TWO WRENCHES. Don't allow the fittings to turn or twist when tightening.

## EXPANSION VALVE

The expansion valve/ liquid line/drier connects to one of the plate fittings and at the discharge fitting on the compressor section.

After assembly externally mounted, valves will need to be insulated to prevent frost and sweating.

### Installers Set up

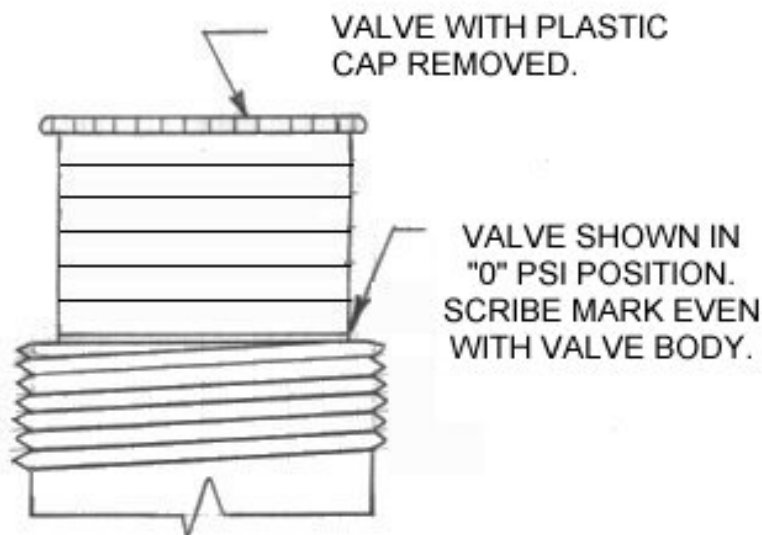

The constant pressure valve sets the refrigerant boiling point. The pressure setting will indicate the minimum temperature that the freezer system can obtain. It has been pre set at the factory. Observing the low side pressure with gauges, note that the pressure is constant at 2 to 8 psi. , depending on the valve setting. If adjustment is needed, set the valve pressure at the lowest possible pressure setting that will cool the box. The plate temperature will always be at least 5 to 10 degrees colder than the box. Problems will occur when the pressure is high and the thermostat is set low; the thermostat will never be satisfied. The compressor will never stop. Refer to a pressure temperature chart for R-134a. to be sure the plate can reach the thermostat cutout temperature.

A poorly insulated box will require a higher pressure setting to obtain any freezing and will never freeze rock hard.

## Installing a Jumper

If installing a multi plate system, use the jumper to connect the remaining tube on the first plate to either tube on the second plate.

## Installing the Return Line

Connect a return line to the remaining tube. This return line connects to the compressor.

Support the tubing every 18 inches as necessary with mountable tie wraps and self tapping screws.

## THERMOSTAT

### Thermostat Location

The thermostat is low voltage and is connected and powered by the transformer in the compressor cabinet. Mount the thermostat in a convenient location where the sensing bulb will reach a mounting screw on a plate. It is necessary that the bulb of the sensor have good thermal contact with the plate. Attach the bulb to the plate using the stainless clip. Use one of the existing plate mounting screws as an attachment point.

**On multiple plate installations, the thermostat must sense the last plate in the series after the valve.** The probe temperature is displayed when 110-volt power is available. The probe temperature is not the cabinet temperature. The probe temperature is always colder than the cabinet.

### Thermostat Wiring

The Ranco Electronic Temperature Control operates on low voltage (24VAC) supplied by the transformer in the compressor cabinet.

A 15' wiring harness is fitted to the thermostat. Use red, blue, and white 16-gauge wire to extend this harness if a longer length is needed. Attach the wires to the terminal strip using #8 ring terminals, matching corresponding wire color.

## Thermostat Operation

The thermostat is pre-set and locked at the factory. When locked the keypad is disabled and changes to the settings cannot be made. To change the settings the lockout switch must be placed in the unlock position.

To access the lockout switch:

1. Switch off the power.
2. Remove the four screws and cover.
3. Slide the lockout switch to the right to the unlock position.
4. Replace the cover.
5. Re-power the system.
6. To program refer to table below.

Step	Display	Description
1	F or C	Fahrenheit or Celsius Scale Press the <b>set</b> key once to access the Fahrenheit / Celsius scale. The display will show the current status, either F for degrees Fahrenheit or C for degrees Celsius. <i>The thermostat has been pre-set at the factory for Fahrenheit.</i> Press the up or down arrow key to choose between the F and C.
2	S1 (blinking)	Setpoint Temperature Press the <b>set</b> key again to access the setpoint. The display will show the current set point. <i>The setpoint has been pre-set to 0 degrees F.</i> Press either the up or down arrow key to change the setpoint to the desired temperature.
3	DIF 1 (blinking)	Differential Temperature Press the <b>set</b> key again to access the differential. The display will show the current differential. <i>The differential temperature has been pre-set at 5 degrees F.</i> Press either the up or down arrow key to increase or decrease the differential setting.
4	C1 / H1	Cooling or Heating Mode Press the <b>set</b> key again to access the heating or cooling mode. The display will show the current mode. C1 for cooling or H1 for heating. The Thermostat has been pre-set for C1. <b>Do not change this setting.</b> The BF does not work in heat mode. Press the set key once more and programming is complete.

Note: Pressing the set key accepts the setting and brings you to the next step. You must push the **set** key through all steps to return to the temperature display to allow the compressor to operate.

## 110-VOLT CIRCUIT

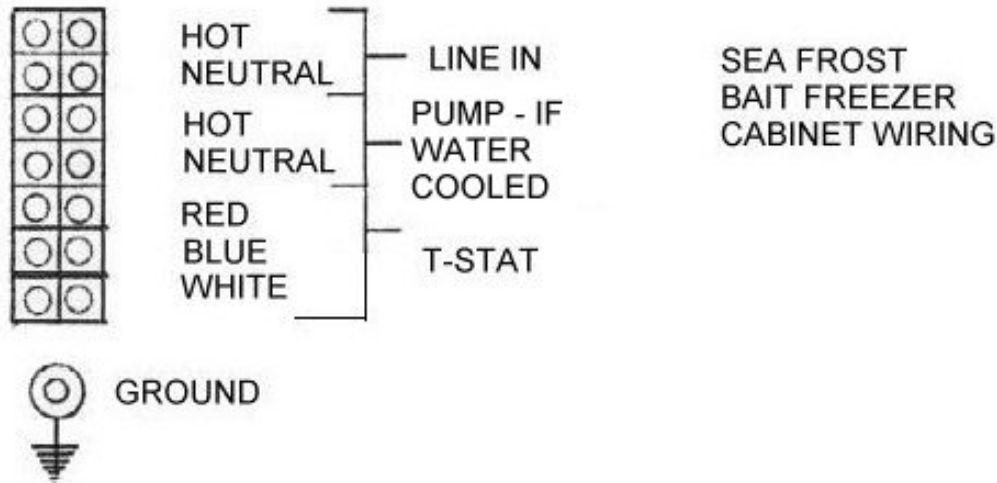

A separate 15-amp breaker is required for the 110-volt supply. This circuit powers the thermostat through a built in transformer. *For operation, it is necessary to have power at all times.*



## RE-CHARGING OR ADDING REFRIGERANT

Adding refrigerant will not change the suction (low) side pressure. Do not charge more than 12 oz of R-134a in an empty system. Typical head pressure will be about 25 degrees above air temp. If you are adding refrigerant and exceed the calculated head pressure you are overcharging and may risk breaking the compressor valves. Do not adjust the charge to prevent frost back. The return line may be well below freezing in normal operation. Contact the factory if you have questions.

## READING THE SIGHT GLASS

SIGHT GLASS DETAIL		
Clear or empty	Stationary bubbles	Foam (low charge)
		

A clear sight glass, when the compressor is operating, signifies a sufficiently charged system. To determine the meaning of "clear", notice the appearance of the RFD sight glass when the system is at rest with the compressor off. This is a "clear" glass.

**WARNING:** A clear sight glass can also indicate a completely EMPTY system. Anytime the compressor is started, white foam should appear in the sight glass indicating that the refrigerant is present. This foam may disappear quite quickly but, IF NO FOAM IS EVIDENT and the system is not cooling, the system is empty. DO NOT OPERATE THE SYSTEM in this empty condition. Operation in this mode will ruin the compressor. Turn off the main breaker to the control panel to prevent operation until the system can be properly leak tested and recharged.

Fast moving white foam with the compressor operating indicates an insufficient charge level. Watch closely for a transition from foam to total liquid, (indicated by a clear sight glass). This transition point can be missed if proper attention is not given. Also, IT IS POSSIBLE for the sight glass to show large bubbles even when the charge is sufficient, so it is important to differentiate between "foam" and "bubbles". The foam condition has velocity and direction; the bubbles are large, temporary, and nearly stationary. Do not try to chase away these larger bubbles with more refrigerant: overcharging will then occur. Air in the system may give a false sight glass reading, which could lead to overcharging. If in doubt, discharge a suspected overcharged system to continuous foam and slowly add refrigerant to clear the glass. MONITOR THE SIGHT GLASS CONTINUALLY since the glass will not indicate when the system is overcharged.

In a warm system, when the cabinet is above freezing (32.F) upon start-up, the sight glass may take several minutes to clear. A cold cabinet may show a clear glass within seconds of start-up.

## **TROUBLESHOOTING**

The low side operating pressure of the system **will not** indicate the amount of refrigerant in the system. The valve will not give proper operation or pressure if it is undercharged. Check the valve scribe line. It should correlate to gauge pressure.

The system requires enough refrigerant to supply liquid to the valve. If the valve has a steady hissing sound then the charge is ok. If the valve is sputtering then it is low. If the valve is making a noticeable roar it is empty. If the low side pressure is properly set the high side pressure will be 80 to 135 psi depending on the air temperature (50 to 95 degrees F.) at the unit. Almost immediately upon start up the valve body will begin to frost.

**Do not add refrigerant charge to a pre-charged system.  
Maximum charge 12 oz. R-134a**



## DEFROSTING

The unit will require defrosting from time to time as the frost layer builds up.

Allowing the unit to warm above freezing is one method of defrosting. Warm water or a hair dryer is also a quick method. Plates can be scraped with a spatula or ice scraper to remove excessive frost build up.

<b>Bait Freezer Specifications</b>			
	<b>BF 1</b>	<b>BF 2</b>	<b>BF 3</b>
<b>Amp Start (LR)</b>	28	28	30
<b>A.C. amp draw</b>	3.8 @ 110 volts	3.8 @ 110 volts	4 @ 110 volts
<b>Horsepower</b>	1/4	1/4	3/8
<b>BTU per hour</b>	760 @ -10 F.	760 @ -10 F.	930 @ -10 F.
<b>Height</b>	16"	16"	16"
<b>Width</b>	14.5"	14.5"	14.5"
<b>Depth</b>	7.5"	7.5"	7.5"
<b>Cooling</b>	Ducted Air Cooled	Ducted Air and Water Cooled (remote water pump required)	Ducted Air and Water Cooled (remote water pump required)
<b>Compressor unit weight</b>	36 lbs	36 lbs	42 lbs

